

**Teta 4 / Ławka miejska**

Rodzina mebli TETA

Rodzaj stali	Rodzaj Drewna	Wymiary		
		Dł.	Szer.	Wys.
Stal zwykła / ocynk i lakier proszkowy	Drewno krajowe - świerk			
Stal nierdzewna	Drewno egzotyczne - iroko	150 cm	79,5 cm	72 cm

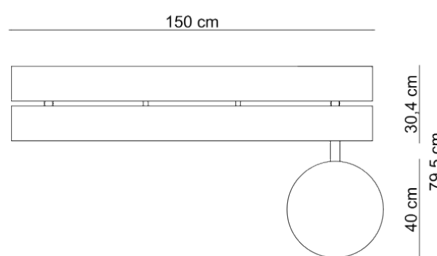
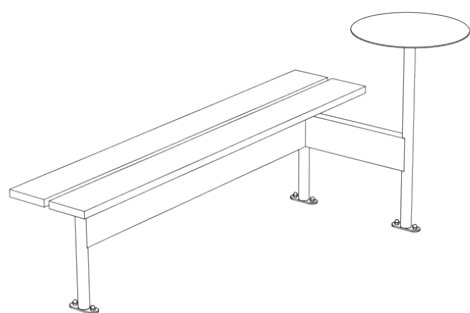
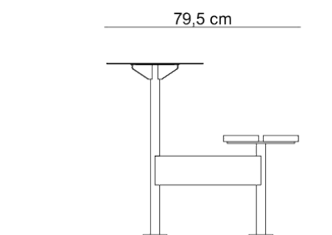

improdukcja®

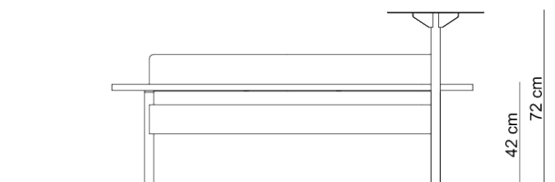
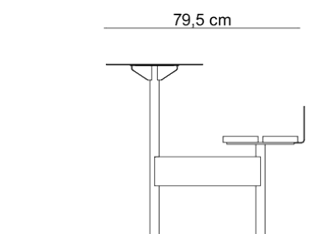

Dystanse siedziska w wariantach: dwa pojedyncze / jeden podwójny
- opcja dodatkowo płatna

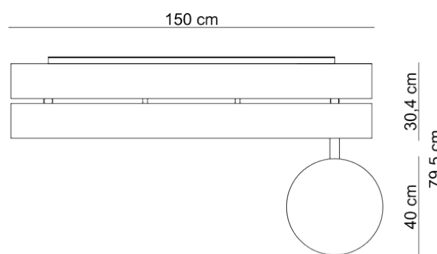
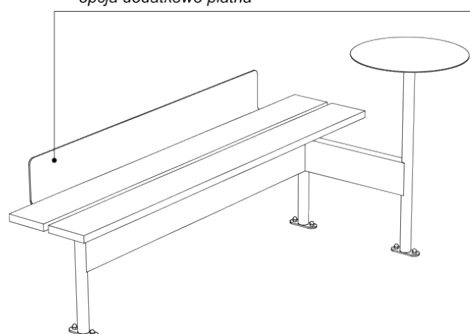

improdukcja®